

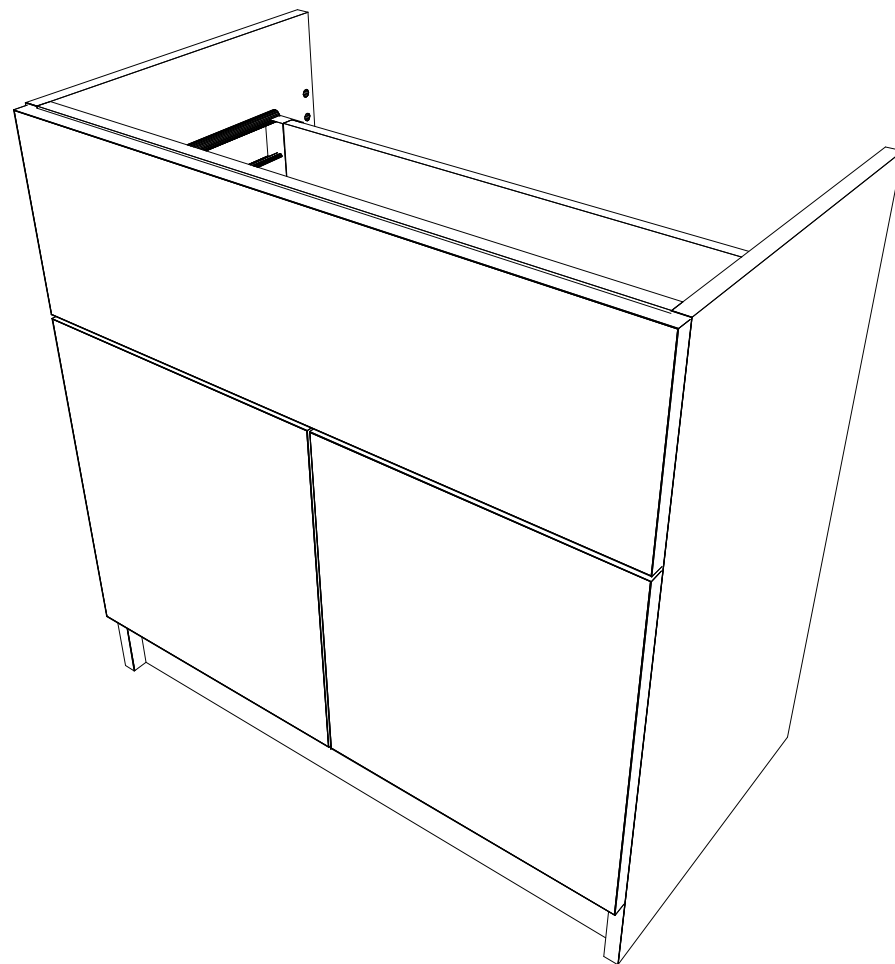

**bath  
store**

(800W x 810H x 450D) +/- 2mm

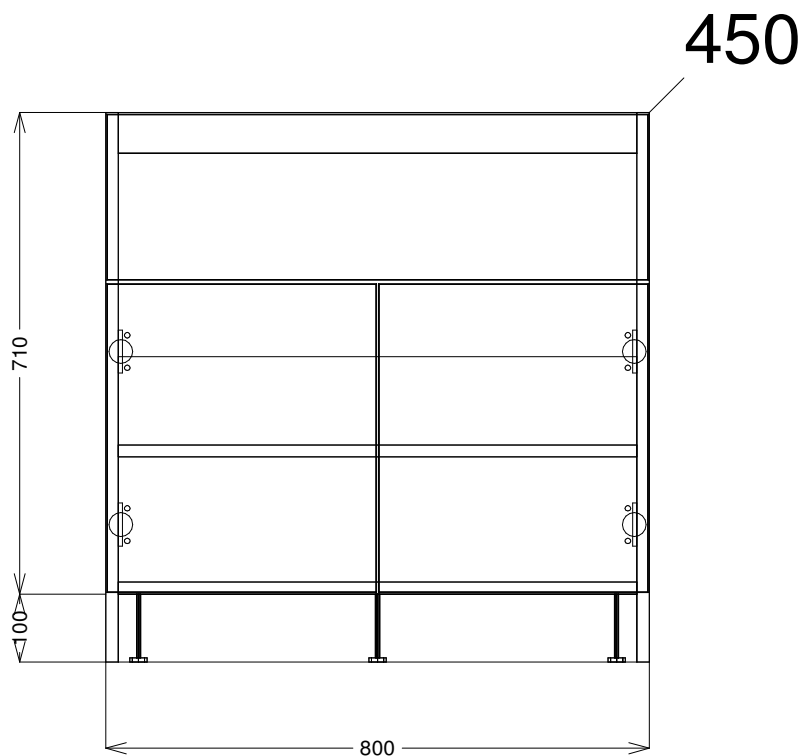

# VERMONT – BASIN DIMENSIONS (2)

