

SWIFTDECK



Complete Garden Decking Kit

Installation Instructions for SD-4747COR Swift Deck 4.7 x 4.75m

1

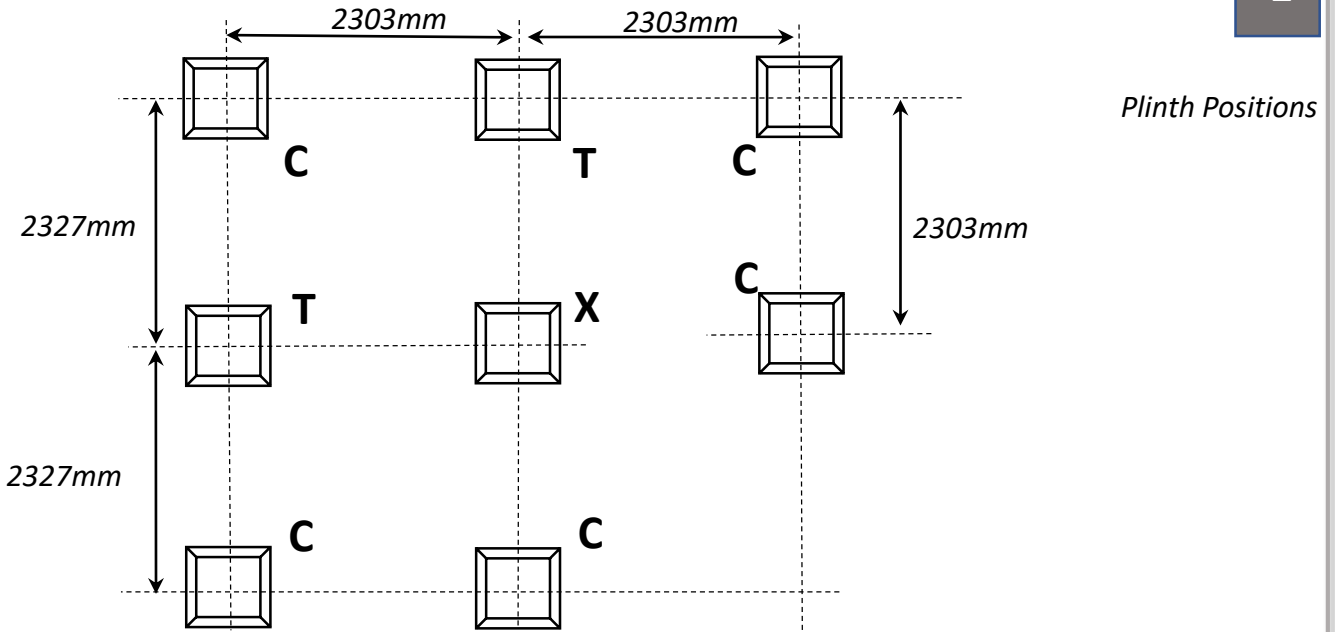

Plinth Positions

Bracket key – C=corner: T=T-shaped: X=cross shaped



C=corner



T=T-shaped

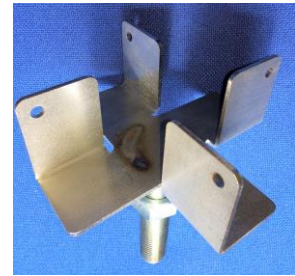

X=cross shaped

Option 1 - Plinth above ground

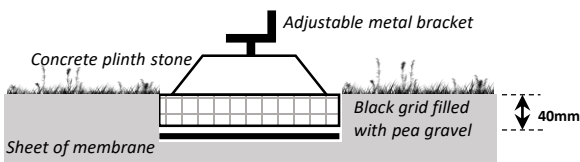

Option 2 - Plinth below ground

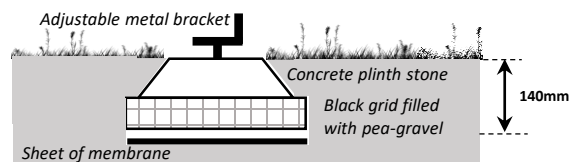

2

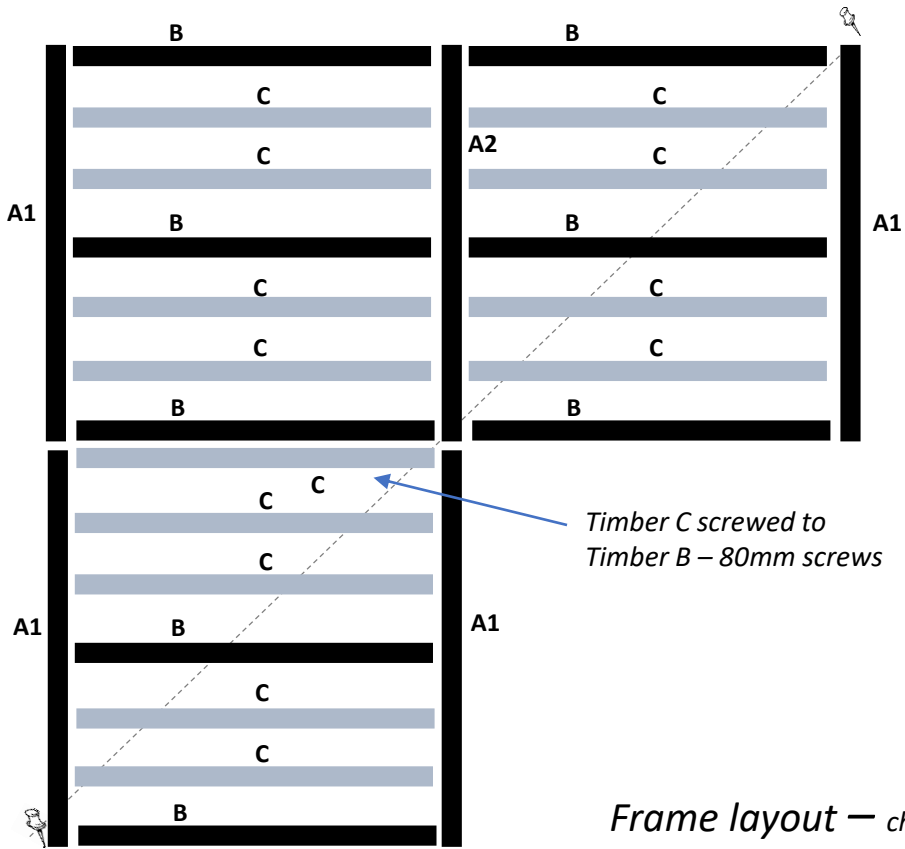

80mm screws at corners

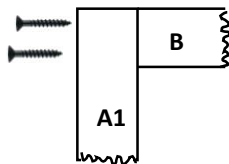

30mm screws through joist hangers

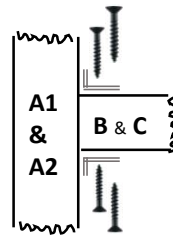

80mm screws through joists

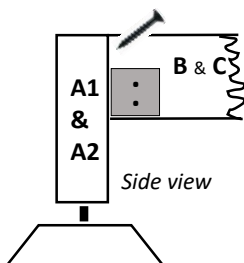

40mm screws through plinth brackets

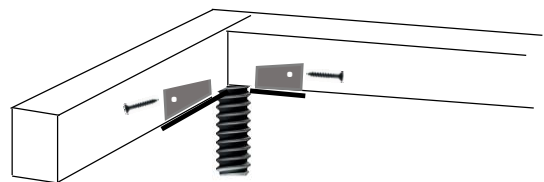

5

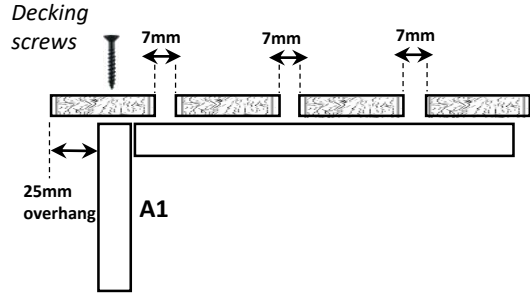
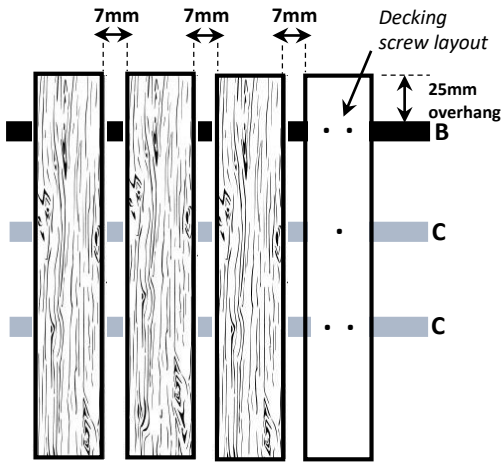

Decking board positions

6

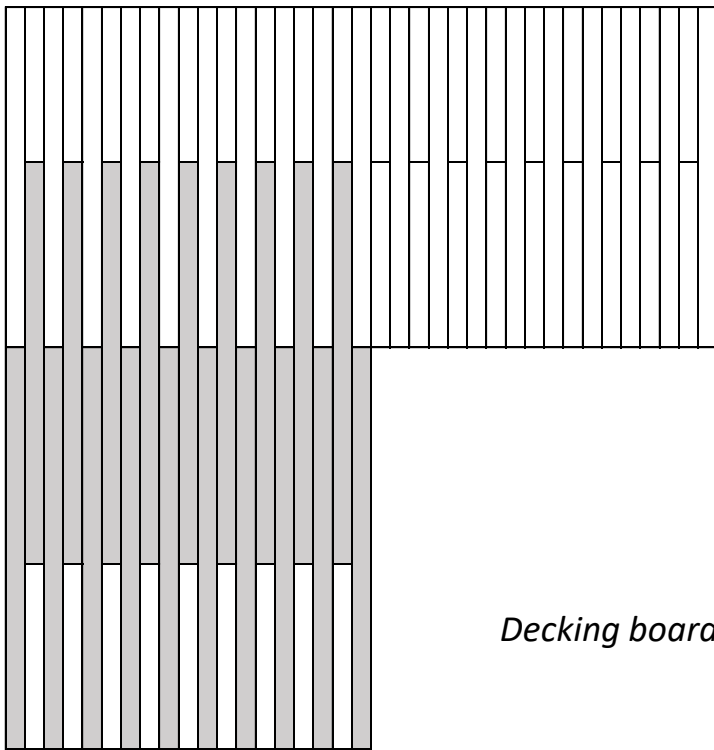

Decking board Pattern

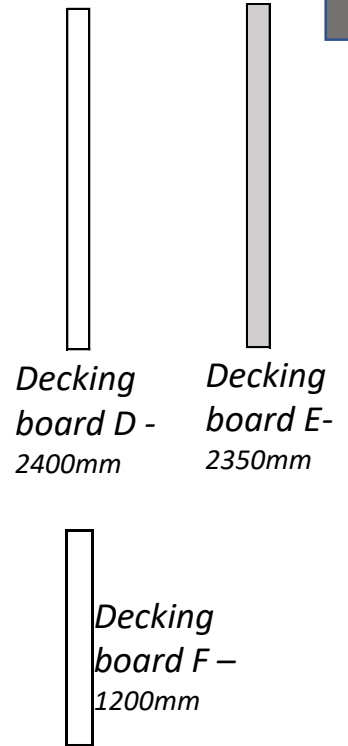

Decking board D - 2400mm

Decking board E - 2350mm

Decking board F - 1200mm

7

Mount Facia Grass with 30mm screws

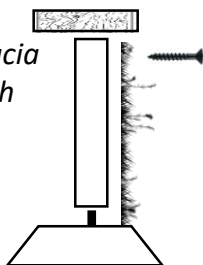

SWIFTDECK



Complete Garden Decking Kit

01944 758455

sales@swiftfoundations.co.uk

www.swiftfoundations.co.uk

Swift Foundations Ltd - Top Barn - Beckhouse Farm - Scagglethorpe - Malton - North Yorkshire - YO17 8ED